



Molto di più su [www.edilkamin.com](http://www.edilkamin.com)

**RIVESTIMENTI**



**EDILKAMIN**  
TECNOLOGIA DEL FUOCO

RIVESTIMENTI CONTEMPORANEI E



TRADIZIONALI

per offrire la possibilità di arredare tanti tipi di casa e di scegliere fra tanti diversi stili.





## SQUARE

### Rivestimento:

Un grande pannello quadrato in tre varianti di materiale: acciaio, vetro e marmo.

**Focolare:** Forte N, cm 160x34x160h

Marmo arabescato bianco



Acciaio satinato



Vetro blu



Vetro bianco



Vetro antracite





# AIR

## Rivestimento:

Cornice in tre diversi materiali, Travertino Rosso, Stonelite Bianco Antares e Vetro serigrafato Rosso con tondini in acciaio inox lucido.

## Focolari:

- Luce 54, Luce Plus 54, Pellinsert 54, cm 106x4x75h;
- Luce 62, Luce Plus 62, Pellbox SCF, cm 110x4x81h
- Acquatondo 22 piano, Forte, cm 110x4x72h (solo modello Stonelite)
- Airfire port. piano, Firetronix Line, Thermofire port. piano, cm 110x4x72h (solo modello Stonelite)
- Cristal 76, Double, cm 110x4x76h (solo mod. Stonelite)  
mediante cornice optional sono abbinabili: Deco, Riga 54, Piana.

Vetro rosso



Stonelite Bianco Antares



Travertino rosso



## FOCO

### Rivestimento:

Cornice realizzata interamente in ghisa decorata a bassorilievo. Modello 1, senza soglia a pavimento; modello 2, con soglia incassata o appoggiata (profondità soglia 41cm).

### Optional:

Panchetta 120x41x41 h; 180x41x41h.

### Focolari:

- Flat 120, Forte, cm 120x97

Soglia appoggiata



Vetro azzurro



## WIND

### Rivestimento:

Cornice in vetro sagomato, temperato e serigrafato giallo o azzurro.

### Focolari:

- Luce 54, Luce Plus 54, Pellinsert 54, cm 121x7x101h
  - Luce 62, Luce Plus 62, Pellbox SCF, cm 126x7x108h
- mediante cornice optional sono abbinabili: Deco, Piana, Riga 54.

Vetro giallo



# POP

## Rivestimento:

Rivestimento in granito nero con inserti acciaio inox satinato. Disponibile in due lunghezze 3 m e 2,4 m.

## Focolare:

- Flat 120, cm 240x23x70h (vers. ridotta)
- Flat 120, cm 300x23x70h





## SAHARA 100 ◀

### Rivestimento:

Cornice in travertino chiaro lucido, con inserti in acciaio inox.

Struttura portante in metallo verniciato antracite.

### Focolare:

- Flat 100, cm 171x7x98h



## ▶ SAHARA

### Rivestimento:

Cornice in travertino beige lucido e inserti in acciaio inox. Struttura in metallo verniciato antracite.

### Focolari:

- Luce 54, Luce Plus 54, Pellinsert 54, cm 120x4x83h
- Luce 62, Luce Plus 62, Pellbox SCF, cm 123x4x88h
- Acquatondo 22 Piano, Forte, cm 123x4x82h

mediante cornice optional sono abbinabili: Deco, Riga 54, Piana.



# HIGH TECH

Acciaio inox

## Rivestimento:

Cornice in metallo verniciato, rivestita con moduli in acciaio inox satinato o con moduli in rame con finitura vibrato e verniciati a polvere trasparente.

## Focolari:

- Luce 54, Luce Plus 54, Pellinsert 54, cm 120x7x105h
  - Luce 62, Luce Plus 62, Pellbox SCF, cm 131x7x114h
- mediante cornice optional sono abbinabili: Deco, Riga 54, Piana.

Rame



# JUNGLE

## Rivestimento:

Cornice in travertino chiaro con composizioni a mosaico di mattonelle in differenti materiali (vetro, ceramica, inox)

## Focolari:

- Luce 54, Luce Plus 54, Pellinsert 54, cm 115x7x102
  - Luce 62, Luce Plus 62, Pellbox SCF, cm 120x7x109
- mediante cornice optional sono abbinabili: Deco, Riga 54, Piana.

## ONYX

### Rivestimento:

Cornice a sbalzo in marmo arabescato bianco di forte spessore, con finitura lucida.

### Focolare:

- Firetronix Line, Airfire portel. piano, Thermofire portel. piano, cm 135x10x98h



## ARABESQUE

### Rivestimento:

Cornice in marmo tigrato orientale lucido e acciaio inox satinato o in marmo arabescato bianco lucido con inserti in acciaio.

### Focolari:

- Luce 54, Luce Plus 54, Pellinsert 54, cm 120x4x81h
- Luce 62, Luce Plus 62, Pellbox SCF, cm 123x4x88h mediante cornice optional sono abbinabili: Deco, Riga 54, Piana.

Marmo arabescato bianco lucido





# WALL

## Rivestimento:

Modello in travertino chiaro

## Focolare:

- Cristal 90, cm 178x7x140h



# WOOD

## Rivestimento:

Struttura in acciaio e rivestimento in legno wengè a fasce orizzontali con andamento concavo.

## Focolari:

- Luce 54, Luce Plus 54, Pellinsert 54, cm 180x14x90h
- Luce 62, Luce Plus 62, Pellbox SCF, cm 180x14x96h mediante cornice optional sono abbinabili: Deco, Riga 54, Piana.

## BOLD

### Rivestimento:

Cornice con sagoma convessa in acciaio bronzato con fori sulla parte superiore e inferiore.

### Focolari:

- Luce 54, Luce 54 Plus, Pellinsert 54, cm 132x15x99h
  - Luce 62, Luce 62 Plus, Pellbox SCF, cm 137x15x106h
- mediante cornice optional sono abbinabili: Deco, Riga 54, Piana



## FASHION

### Rivestimento:

Cornice strombata in stonelite nero seppia con contorno in mosaico.

### Focolari:

- Luce 54, Luce Plus 54, Pellinsert 54, cm 131x9x118h
  - Luce 62, Luce Plus 62, Pellbox SCF, cm 131x9x120h
- mediante cornice optional sono abbinabili: Deco, Riga 54, Piana.

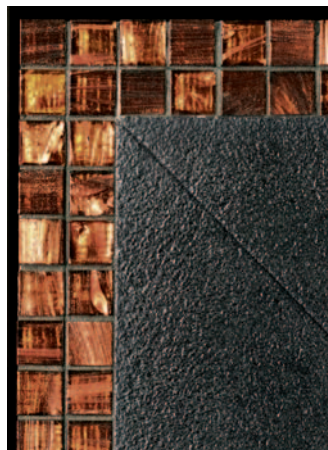

## INCAS

### Rivestimento:

Cornice in travertino chiaro con inserti di diverse tonalità. Il pannello è in marmo chiaro bocciardato. La struttura portante è in acciaio.

### Focolari:

- Luce 54, Luce Plus 54, Pellinsert 54, cm 122x7,5x149h
  - Luce 62, Luce Plus 62, Pellbox SCF, cm 132x7x157h
- mediante cornice optional sono abbinabili: Deco, Riga 54, Piana.



## MEXICO

### Rivestimento:

Cornice in travertino naturale con intarsi tono su tono. Pannello posteriore in stonelite chiara bocciardata e struttura in acciaio.

### Focolari:

- Firetronix Line, Airfire portellone piano, Thermofire portellone piano, cm 146x8x113h
- Acquatondo 22 piano, Forte, Acquatondo 29 piano, Screen 80, cm 146x9x113h



## DARVON

### Rivestimento:

Modello in acciaio bronzato con soglia in marmo giallo reale.

### Focolare:

- Cristal 45, cm 146x88x181h con copricanna telescopico (altezza regolabile da cm 270 a 300h)



## QUADRO

### Rivestimento:

Modello in acciaio verniciato in due tonalità di grigio (canna non inclusa).

### Focolare:

- Idro 30, cm 94x60x103h

# DOOR

## Rivestimento:

Modello in metallo con ante, trattate con processo di ottonatura anticata. Quando le ante sono chiuse, attraverso i piccoli fori si intravede la luce della fiamma.

## Focolari:

- Firetronix Arc, Airfire portellone tondo, cm 108x34x170h



ante chiuse



# RIVESTIMENTI CONTEMPORANEI

**BIX BOX** acciaio inox



**BIX BOX 62** acciaio bronzato



**BIX BOX 100** acciaio inox



## ► **BIX BOX** **BIX BOX 62** **BIX BOX 100**

### **Rivestimento:**

Cornici in due varianti di materiali:  
acciaio inox, acciaio bronzato.  
(completo di parascintille a pavimento  
per Cristal/Double)

### **Focolari:**

- Cristal 45, cm 72x26x103h
- Cristal 76, Double, cm 103x26x85h
- Cristal 90, cm 117x26x98h
- Firetronix Line, Airfire portellone piano, Thermofire portellone piano, cm 96x7x80h
- Acquatondo 22 Piano, Forte, cm 104x6x81h (solo mod. acciaio inox)
- Luce 62, Luce Plus 62, Pellbox SCF, cm 109x26x106h (Bix Box 62)
- Flat 100, cm 130x26x76h (Bix Box 100)



# DROMOND

Stonelite nero seppia e inserti orizzontali in marmi rossi

## Rivestimento:

Modello in stonelite bianco ambra o nero seppia (foto grande).

Optional: inserti con marmi di varie tonalità.

## Focolari:

- Cristal 45, 100x38x174h
- Cristal 76, 131x38x150h
- Cristal 90, 145x38x174h
- Acquatondo 22 piano, Forte, cm 131x38x172h (solo mod. stonelite bianco ambra)
- Stile, 118x38x195h (solo mod. stonelite bianco ambra)



Stonelite bianco ambra e inserti verticali in marmi rosa



Stonelite bianco ambra



## METAL

### Rivestimento:

Cornice in acciaio verniciato grigio di forma lineare con focolare prismatico.

### Focolari:

- Firetronix Poli, Airfire prismatico, cm 144x5x83h



## ABBAY

### Rivestimento:

Modello a parete con spalle in metallo verniciato grigio antracite e soglia in marmo bronzettato

### Focolare:

- Cristal 76, cm 150x86x95h



## SILVER

### Rivestimento:

Cornice in acciaio verniciato a polvere grigio chiaro, impreziosita da incisione a effetto geometrico.

### Focolari:

- Luce 54, Luce Plus 54, Pellinsert 54, cm 103x4x90h
- Luce 62, Luce Plus 62, Pellbox SCF, cm 107x4x96h
- Airfire Portel. piano, Firetronix Line, Thermofire Portel. piano, cm 92x5x81h
- Acquatondo 22 piano, Forte, cm 102x3x83h
- Acquatondo 29 piano, cm 110x3x83h
- Cristal 76, Double, cm 102x3x87h
- Flat 100, cm 129x3x79h

mediante cornice optional sono abbinabili: Deco, Riga 54, Piana.



## WHITE

### Rivestimento:

Cornice squadrata lineare realizzata in acciaio smaltato bianco.

### Focolari:

- Firetronix Line, Airfire portellone piano, Thermofire portellone piano, cm 96x7x80h



## EASY

### Rivestimento:

Cornice bombata in acciaio verniciato grigio.

### Focolari:

- Firetronix Arc, Airfire tondo, cm 96x29x80h



## IRON

### Rivestimento:

Cornice strobata in acciaio verniciato a polvere grigio scuro.

### Focolari:

- Luce 54, Luce Plus 54, Pellinsert 54, cm 108x9x95h
  - Luce 62, Luce Plus 62, Pellbox SCF, cm 113x9x102h
  - Airfire Portel. piano, Firetronix Line, Thermofire Portel. piano, cm 100x8x89h
  - Acquatondo 22 piano, Forte, cm 108x8x89h
  - Acquatondo 29 piano, cm 116x8x89h
  - Cristal 76, Double, cm 108x8x93h
  - Flat 100, cm 135x8x85h
- mediante cornice optional sono abbinabili: Deco, Riga 54, Piana.

# PURE

## Rivestimento:

Cornice disponibile in due varianti di materiali: acciaio dorato opaco; acciaio inox vibrato.

## Focolari:

- Screen 80, cm 115x6x82h
- Screen 100, cm 135x6x82h

acciaio dorato opaco



acciaio inox vibrato



# SMILE

## Rivestimento:

Cornice in pietra serena e stonelite bianco ambra, completa di telaio metallico di supporto

## Focolari:

- Screen 80, cm 133x5x92h
- Screen 100, cm 153x5x92h

## SAFARI

### Rivestimento:

Modello in pietra serena con decorazione lineare in graniglia di vetro, completa di telaio metallico per ancoraggio a muro.

### Focolari:

- Screen 80, cm 129x3,5x90h
- Screen 100, cm 149x3,5x90h



## LASER

### Rivestimento:

Modello in pietra serena e stonelite nero seppia con decorazione geometrica impreziosita da resina effetto brillante.

Completa di telaio metallico per ancoraggio a muro.

### Focolari:

- Screen 80, cm 145x4,5x106h
- Screen 100, cm 165x4,5x106h





## STEEL

### Rivestimento:

Modello in acciaio verniciato a polvere, grigio chiaro.

### Focolari:

- Screen 80, cm 115x4x66h
- Screen 100, cm 135x4x66h



## GREY

### Rivestimento:

Modello in acciaio verniciato a polvere, grigio scuro.

### Focolari:

- Screen 80, cm 121x9x92h
- Screen 100, cm 141x9x92h

## ALICANTE

### Rivestimento:

Cornice in stile Luigi XV realizzata in breccia tavira.

### Focolari:

- Riga 54, Deco, cm 126x25x100h



## PARIGI

### Rivestimento:

Cornice in marmo rosa portogallo rifinita a mano. Disponibile in versione grande (**Parigi Uno**) e in versione media (**Parigi Due**), con frontalino inferiore in marmo)

### Focolari:

- Tonda, Piana, cm 155x30x117h (Parigi Uno)
- Forte, cm 133x26x114h (Parigi Due)

## CLASS

**Rivestimento:**

Cornice classica in marmo giallo d'istria levigato, collocabile ad angolo o a parete.

**Focolare:** Forte, cm 138x40x122h



## TOSCA

**Rivestimento:**

Cornice realizzata interamente in legno anticato, collocabile ad angolo o a parete.

**Focolari:**

- Forte, cm 131x19x117h



## ROMA DUE

### Rivestimento:

Cornice in stile impero realizzata in marmo bianco carrara, con frontalino inferiore in marmo. Collocabile ad angolo o a parete.

### Focolari:

- Forte, cm118x25x114h



## CAROUSEL ◀

### Rivestimento:

Cornice in stonelite avorio con inserti in tozzetti di travertino noce e stonelite beige. Collocabile ad angolo o a parete.

### Focolari:

- Stile, 100x100x141h (angolo)
- Stile, 107x20x141h (parete)



## ▶ CANARIA

### Rivestimento:

Cornice a sviluppo verticale in marmo tigrato orientale lucido e levigato. Collocabile ad angolo o a parete.

### Focolari:

- Stile, cm 112x112x136h (angolo)
- Stile, cm 108x20x136h (parete)

## TRIS

MEDIO/PICCOLO

### Rivestimento:

Caminetto angolare, con spalle e zoccoli in marmo trani bocciardato, trave e frontalino inferiore in legno, soglia in marmo trani lucido con inserto in rosso asiago.

### Focolari:

- Status, cm 112x112x110h (medio)
- Ego, cm 90x90x109h (piccolo)



Modello ad angolo



## FILOROSSO

### Rivestimento:

Modello in due versioni: ad angolo o a parete, con verticali in marmo trani bocciardato, soglia in marmo trani lucido con inserti in rosso asiago, trave in legno.

### Focolari:

- Titano, 153x90x110h (angolo)
- Riga54, Deco, 148x70x108h (parete)

Modello a parete



## LADY MEDIO

### Rivestimento:

Caminetto angolare compatto con spalle e zoccoli in marmo trani bocciardato, trave in legno noce chiaro. Soglia in stonelite rosa (**Lady Uno**).

### Focolari:

- Status, cm 112x112x105h
- Firetronix Poli, cm 151x121x111h



## LADY PICCOLO

### Rivestimento:

Caminetto angolare poco ingombrante con spalle e zoccoli in marmo trani bocciardato.

Soglia e trave in stonelite rosa (**Lady Uno**) o in marmo verde guatemala (**Lady Due**, foto)

**Focolare:** Ego, cm 87,5x87,5x105h



## MAYALATO APERTO

### Rivestimento:

Caminetto collocabile a parete.  
Marmo bronzettato sabbato con  
soglia ed inserti in marmo giallo reale  
lucido; trave in noce massiccio lucido.

**Focolare:** Titano, cm 136x90x107h



## MAYALATI CHIUSI

### Rivestimento:

Collocabile ad angolo (foto) e a  
parete. Spalle e zoccoli in marmo  
bronzettato sabbato, soglia e inserti  
verticali a scacchi in marmo giallo  
reale lucido. Trave in legno noce  
chiaro.

### Focolari:

- Forte, 113x113x108h (angolo)
- Forte, 134x46x108h (parete)

## DIVA MEDIO

### Rivestimento:

Modello con soglia in marmo rosso verona e zoccolo decorato.

**Focolari:** Riga54, Deco,  
156x72x102h

(non è possibile montare la scatola aria)



## ONDA

### Rivestimento:

Modello ad angolo. Spalle, voltino, zoccoli inferiori in marmo rosa perlino spazzolato/anticato. Soglia e inserti in marmo rosso skiros. Trave in legno.

**Focolare:** Ego, cm 88x88x104h

# RIVESTIMENTI TRADIZIONALI

## LEGO

### Rivestimento:

Modello ad angolo in travertino lavorato a mosaico, soglia e frontalino in marmo trani lucido e sabbato, trave in legno massiccio.

**Focolare:** Titano, cm 125x95x111h



## ABACO

PICCOLO/MEDIO

### Rivestimento:

Modello angolare con tozzetti di travertino in diverse tonalità, soglia stonelite beige lucida con inserto in legno, trave massiccia.

### Focolari:

- Ego, 96x96x109h (piccolo)
- Status, 119x119x108h (medio)

# DOMINO

## Rivestimento:

Modello rustico. Zoccoli e spalle in marmi vicentini a spacco, soglia in pietra di vicenza, trave in legno massiccio.

Contentore metallico verniciato nero.

## Focolari:

- Riga 54, Deco, cm 96x96x114h (angolo)
- Riga 54, Deco, Piana, Tonda, cm 160x77x114h (parete)



# STONE

PICCOLO/MEDIO

## Rivestimento:

Angolare in marmo a spacco di diverse tonalità, profilo spalla zoccoli e soglia in marmo bronzettato sabbiato, trave in legno; contenitore metallico alloggiato nello zoccolo.

## Focolari:

- Riga 54, Deco, Tonda, Piana, cm 120x120x112h (piccolo)
- Status, cm 128x128x112h (medio)



## BAHIA

### Rivestimento:

Modello angolare con soglia in marmo chiaro lucido, pilastrini marmo chiaro bocciardato. Zoccoli e voltino in marmi a spacco di varie tonalità; la trave è in legno massiccio.

**Focolare:** Acquatondo 22 Sfera, cm 112x112x116h (per installazione a vaso aperto)



## ▶ LINEARES

### Rivestimento:

Modello a parete con verticali in marmo chiaro lucido e bocciardato con inserti in marmo marrone. Soglia in marmo chiaro lucido, trave in legno massiccio.

**Focolare:** Acquatondo 29 prismatico, cm 162x105x111h (per installazione a vaso aperto)

## SAXON

### Rivestimento:

Modello angolare in marmo rosso asiago a spacco, soglia e frontalino in marmo giallo reale levigato e lucido; trave in legno.

**Focolari:** Forte, Acquatondo 22 piano, cm 125x125x122h (per installazione a vaso aperto)



## CORDOBA

### Rivestimento:

Modello a parete con verticali in marmo giallo scapezzato e fugato a cemento. Soglia in marmo chiaro lucido, trave in legno massiccio grezzo.

**Focolare:** Acquatondo 29 piano, cm 164x110x113h (per installazione a vaso aperto)

## ELIOS

PICCOLO/MEDIO

### Rivestimento:

Modello angolare con spalle e zoccoli in marmo a spacco giallo reale, soglia e contorno bocca in marmo bronzettato sabbiato, trave in legno. Cassetto in lamiera alloggiato nello zoccolo.

### Focolari:

- Ego, cm 104x104x111h (piccolo)
- Status, cm 116x116x112h (medio)



## LUISA V

### Rivestimento:

Modello rustico collocabile ad angolo (foto) o a parete, **per caminetti a focolare chiuso**, piano fuoco h 38 cm. Realizzato con verticali in marmo vicentini a spacco, soglia in marmo trani lucido, trave in rovere. Optional: per versione ad angolo panca cm 65x27.

### Focolare:

- Titano, cm 156x107x113h (angolo)
- Titano, cm 195x107x113h (parete)



## TEMA UNO/DUE

### Rivestimento:

Modello a parete o ad angolo (foto).

**Tema uno**, marmi vicentini a spacco con soglia in trani lucido. **Tema due**, marmo rosso asiago a spacco con soglia in rosso asiago lucido (foto)

Trave in legno.

Optional:

panchetta cm 60x40 e 90x40.

### Focolare:

- Titano, cm 137x90x116h (angolo)



## GIBILTERRA

### Rivestimento:

Modello a parete con lati chiusi. Verticali in spaccatello rosso fugato a cemento, soglia e architrave in marmo chiaro lucido. Trave in legno massiccio grezzo.

**Focolari:** Forte, Acquatondo 22 piano\*, cm 148x91x111h

\*(per installazione a vaso aperto)



## DAMA

### Rivestimento:

Caminetto a parete in pietra dorata a spacco, soglia in marmo giallo reale ed elementi laterali soglia in legno massiccio come la trave.

### Focolare:

- Deco, cm 150x74x111h



## NOVELLA

PICCOLO/MEDIO

### Rivestimento:

Modello angolare con zoccoli in marmi vicentini a spacco e contenitore in acciaio rivestito legno.

Due varianti per la soglia e contorno bocca: **Novella uno**, in pietra di vicenza (piccolo); **Novella due**, in marmo trani lucido (medio/piccolo).

Trave in rovere massiccio tinto scuro.  
Optional: panchetta cm 60x43

### Focolari:

- Ego, cm 94x94x112h (piccolo)
- Status, cm 113x113x113h (medio)



## DERBY

### Rivestimento:

Modello angolare rustico in mattoncini di travertino giallo burattato ed anticato, soglia in travertino giallo lucidata anticata e trave in legno.

**Focolare:** Titano, cm 145x100x120h



## ANDORRA

### Rivestimento:

Modello angolare con verticali in marmo spaccatello rosso fugato a cemento, soglia e architrave in marmo chiaro lucido. Trave in legno massiccio grezzo.

**Focolare:** Acquatondo 29 prismatico, cm 119x119x111h (per installazione a vaso aperto)



## ARAGONA

### Rivestimento:

Modello a parete con verticali in marmo giallo anticato fugato a cemento, soglia e architrave in marmo chiaro lucido, trave in legno massiccio grezzo.

### Focolari:

Riga 54, Deco, cm 150x76x111h

## ACCESSORI

### ACCESSORI per l'installazione

Tubo flessibile in alluminio  
cm Ø14, Ø16, Ø20

Raccordo R1-R2

Bocchette mandata  
aria calda tipo B1

Griglie ripresa aria interna  
su controcappa

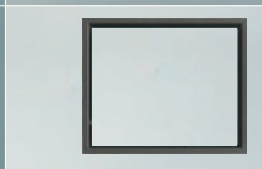
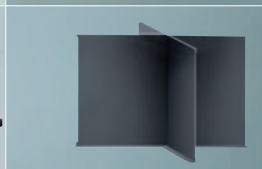
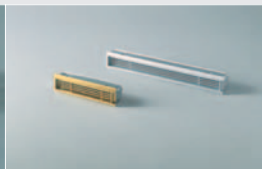
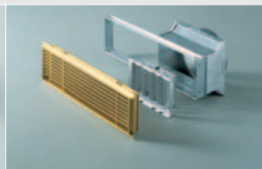

Griglie presa aria esterna

Cavalletto di supporto  
universale Firebox 54/62

Supporto di sostegno  
Pellinsert

Cornice per Firebox 54/62 Piana  
(abbinamento a rivestimenti di Luce)

### ACCESSORI per l'installazione di termocamini

Scambiatore a 3 vie

Scambiatore a piastre  
20/30 piastre

Regolatore elettronico

Vaso espansione



Valvola 3 vie

Valvole di sicurezza -  
sfogo aria - scarico termico

Flussostato

Gruppo spiedo

## ACCESSORI

Attrezzi fuoco  
Curvo Nero

Nero

Nichel

Portalegna Nero

Bidone aspiraceneri  
da usare con aspiratore

Piastra a pavimento

Pellet



# RIVESTIMENTI CONTEMPORANEI

ABBEY

AIR

ARABESQUE

BIX BOX

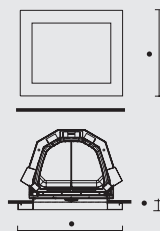
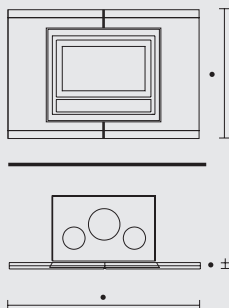
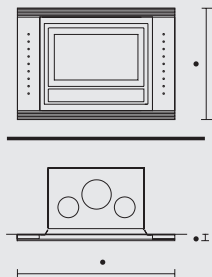
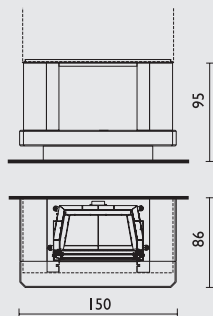

## FOCOLARI

Cristal 76

- Airfire, Firetronix, Thermofire, Acquatondo 22, Forte, cm 110x4x72h
- Cristal 76, Double, cm 110x4x76h
- Luce 54, Luce Plus 54, Pellinsert 54, cm 106x4x75h
- Luce 62, Luce Plus 62, Pellbox SCF, cm 110x4x81h

- Luce 54, Luce Plus 54, Pellinsert 54, cm 120x4x81h
- Luce 62, Luce Plus 62, Pellbox SCF, cm 123x4x88h

- Firetronix, Airfire, Thermofire, cm 96x7x80h
- Acquatondo 22 Piano, Forte, cm 104x6x81h

BIX BOX

BIX BOX 100

BIX BOX 62

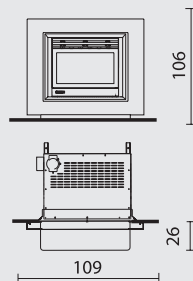
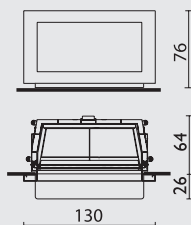
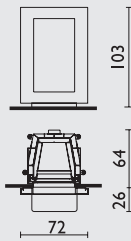
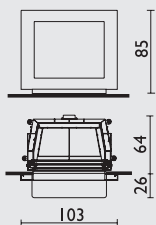
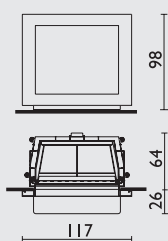

## FOCOLARI

Cristal 90

Cristal 76

Cristal 45

Flat 100

Luce 62, Luce Plus 62, Pellbox SCF



# RIVESTIMENTI CONTEMPORANEI

## BOLD

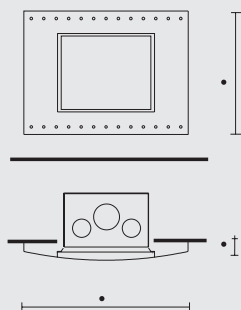

## DARVON

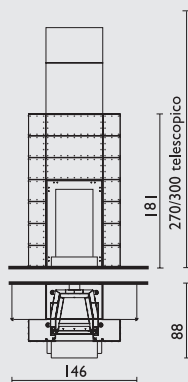

## DOOR

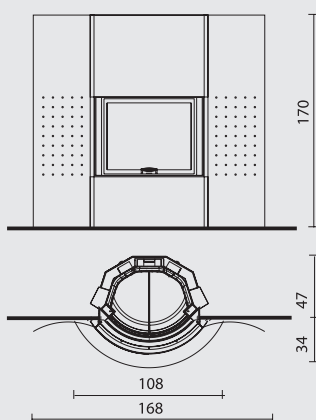

## EASY

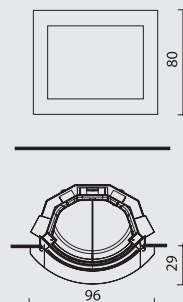

### FOCOLARI

- Luce 54, Luce Plus 54, Pellinsert 54, cm 132x15x99h
- Luce 62, Luce Plus 62, Pellbox SCF, cm 137x15x106h

Cristal 45

Firetronix, Airfire

Airfire, Firetronix

## DROMOND

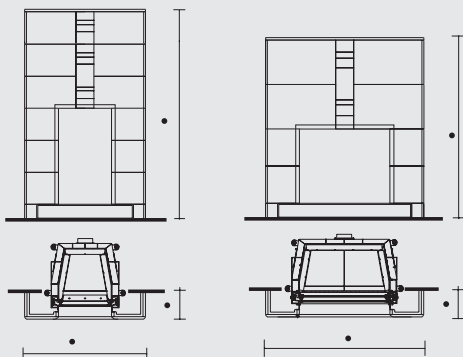

## FASHION

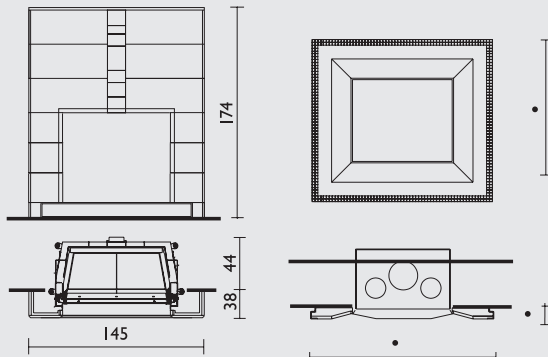

### FOCOLARI

- Cristal 45, cm 100x38x174h
- Stile, cm 118x38x195h

- Cristal 76, 131x38x150h
- Acquatondo 22, Forte, cm 131x38x172h

Cristal 90

- Luce 54, Luce Plus 54, Pellinsert 54, cm 131x9x118h
- Luce 62, Luce Plus 62, Pellbox SCF, cm 131x9x120h

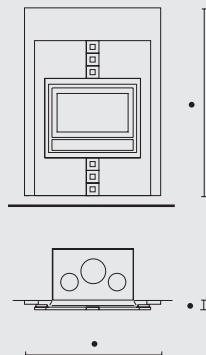
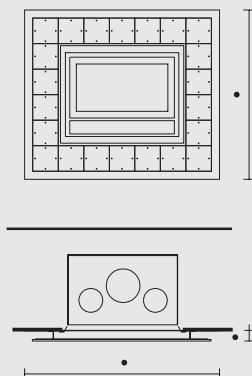
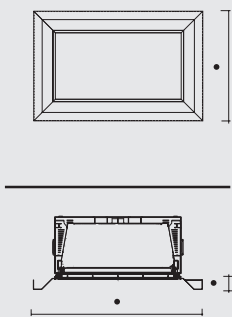
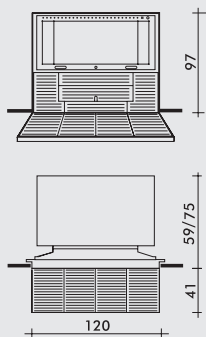
**FOCO**
**GREY**
**HIGH TECH**
**INCAS**

**FOCOLARI**

Flat 120, Forte

- Screen 80, cm 121x9x92h
- Screen 100, cm 141x9x92h

- Luce 54, Luce Plus 54, Pellinsert 54, cm 120x7x105h
- Luce 62, Luce Plus 62, Pellbox SCF, cm 131x7x114h

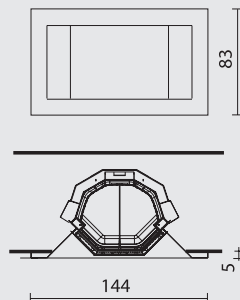
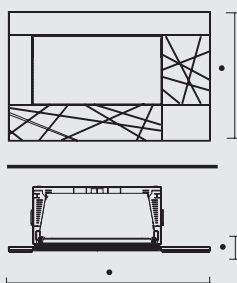
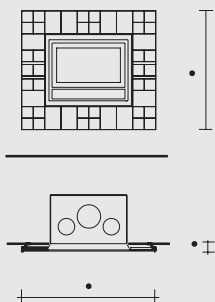
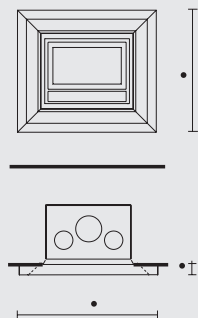
- Luce 54, Luce Plus 54, Pellinsert 54, cm 122x7x149h
- Luce 62, Luce Plus 62, Pellbox SCF, cm 132x7x157h

**IRON**
**JUNGLE**
**LASER**
**METAL**

**FOCOLARI**

- Luce 54, Luce Plus 54, Pellinsert 54, cm 108x9x95h
- Luce 62, Luce Plus 62, Pellbox SCF, cm 113x9x102h
- Airfire, Firetronix, Thermofire, cm 100x8x89h
- Acquatondo 22, Forte, cm 108x8x89h
- Acquatondo 29, cm 116x8x89h
- Cristal 76, Double, cm 108x8x93h
- Flat 100, cm 135x8x85h

- Luce 54, Luce Plus 54, Pellinsert 54, cm 115x7x102h
- Luce 62, Luce Plus 62, Pellbox SCF, cm 120x7x109h

- Screen 80, cm 145x4,5x106h
- Screen 100, cm 165x4,5x106h

Firetronix, Airfire

# RIVESTIMENTI CONTEMPORANEI

## MEXICO

## ONYX

## POP

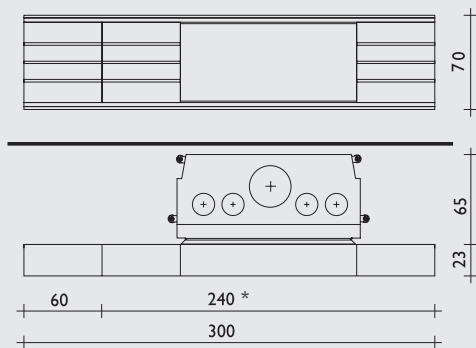
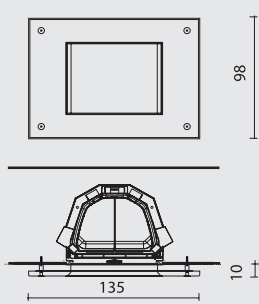
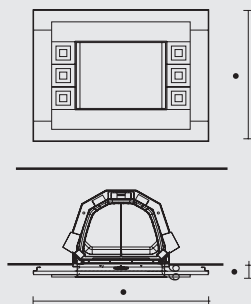

### FOCOLARI

- Firetronix, Airfire, Thermofire, cm 146x8x113h
- Acquatondo 22, Forte, Acquatondo 29, Screen 80, cm 146x9x113h

Firetronix, Airfire, Thermofire

Flat 120 (vers. ridotta)\*

## PURE

## QUADRO

## SAFARI 80 - 100

## SAHARA

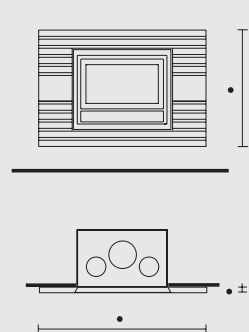
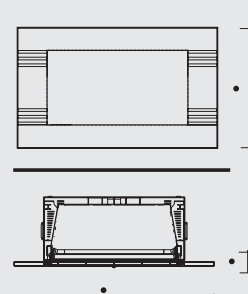
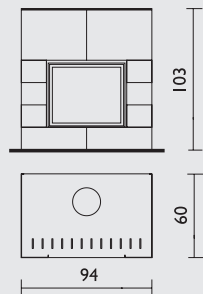
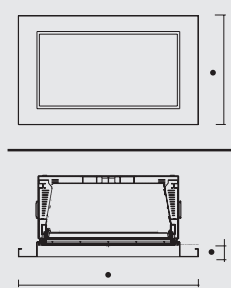

### FOCOLARI

- Screen 80, cm 115x6x82h
- Screen 100, cm 135x6x82h

Idro 30

- Screen 80, cm 129x3,5x90h
- Screen 100, cm 149x3,5x90h

- Luce 54, Luce Plus 54, Pellinsert 54, cm 120x4x83h
- Luce 62, Luce Plus 62, Pellbox SCF, cm 123x4x88h
- Acquatondo 22, Forte, cm 123x4x82h

SAHARA 100

SILVER

SMILE

SQUARE

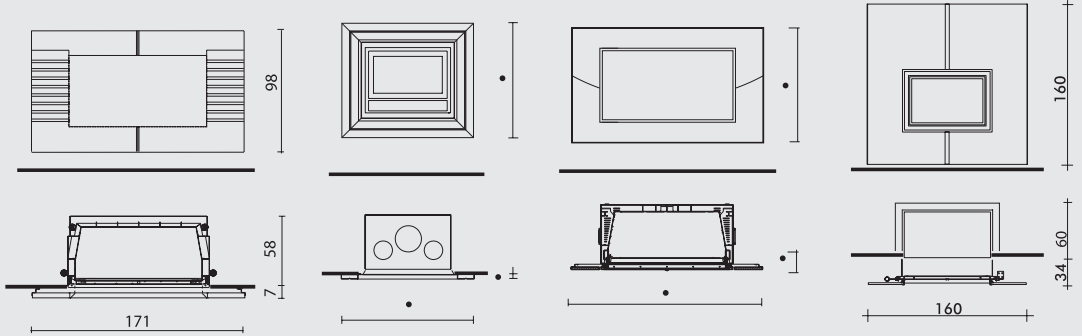

FOCOLARI

Flat 100

- Luce 54, Luce Plus 54, Pellinsert 54, cm 103x4x90h
- Luce 62, Luce Plus 62, Pellbox SCF, cm 107x4x96h
- Airfire, Firetronix, Thermofire, cm 92x5x81h
- Acquatondo 22, Forte, cm 102x3x83h
- Acquatondo 29, cm 110x3x83h
- Cristal 76, Double, cm 102x3x87h
- Flat 100, cm 129x3x79h

• Forte

STEEL

WALL

WIND

WOOD

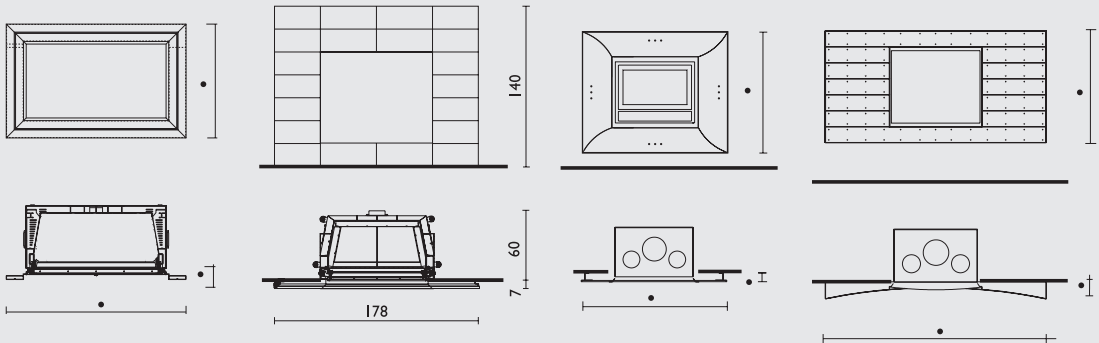

FOCOLARI

- Screen 80, cm 115x4x66h
- Screen 100, cm 135x4x66h

Cristal 90

- Luce 54, Luce Plus 54, Pellinsert 54, cm 121x7x101h
- Luce 62, Luce Plus 62, Pellbox SCF, cm 126x7x108h

- Luce 54, Luce Plus 54, Pellinsert 54, cm 180x14x90h
- Luce 62, Luce Plus 62, Pellbox SCF, cm 180x14x96h



# RIVESTIMENTI TRADIZIONALI

## WHITE

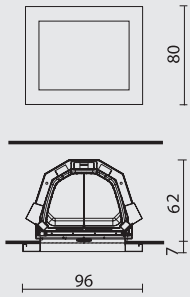

### FOCOLARI

Firetronix, Airfire, Thermofire

## ABACO PICCOLO/MEDIO

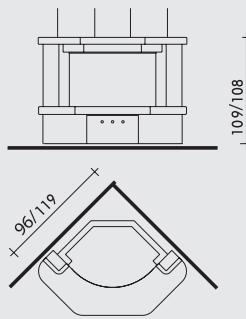

### FOCOLARI

Ego/Status

## ALICANTE

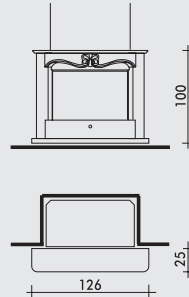

Riga 54, Deco

## ANDORRA

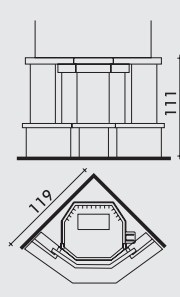

Acquatondo 29

## ARAGONA

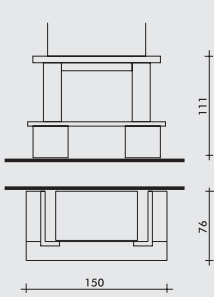

### FOCOLARI

Riga 54, Deco

## BAHIA

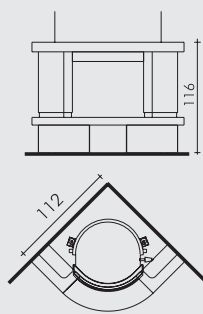

Acquatondo 22 Sfera

## CANARIA

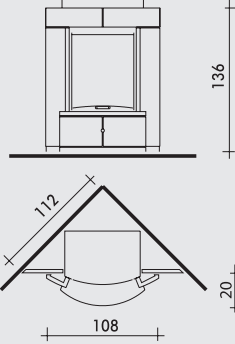

Stile

## CAROUSEL

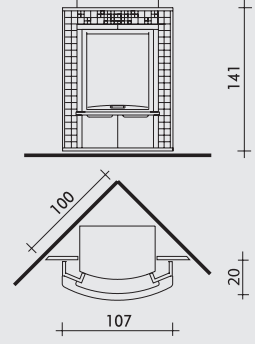

Stile

## CLASS

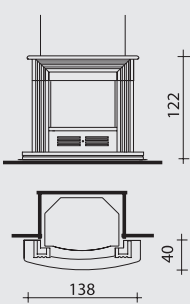

### FOCOLARI

Forte

## CORDOBA

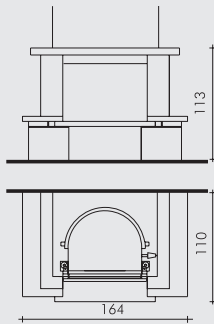

Acquatondo 29

## DAMA

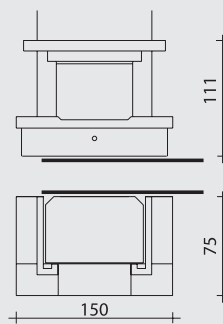

Riga 54, Deco

## DERBY

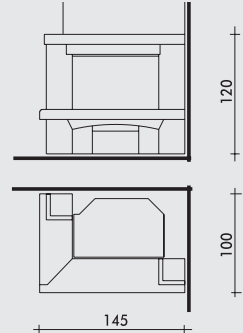

Titano

# RIVESTIMENTI TRADIZIONALI

## DIVA ELIOS DOMINO ANGOLARE DOMINO PARETE

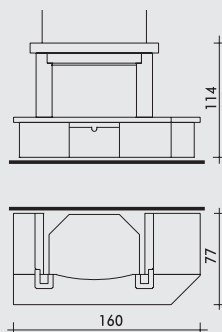
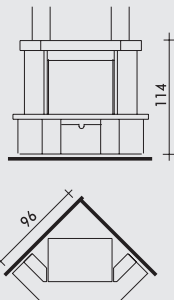
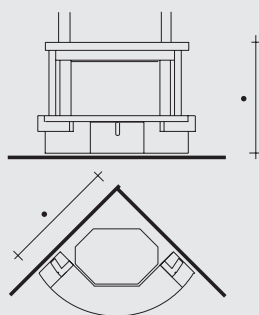
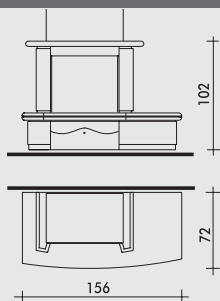

### FOCOLARI

Riga 54, Deco

- Ego, cm 104x104x111h
- Status, cm 116x116x112h

Riga 54, Deco

Riga 54, Deco, Piana, Tonda

## FILOROSSO LATO APERTO FILOROSSO LATI CHIUSI GIBILTERRA LADY PICCOLO/MEDIO

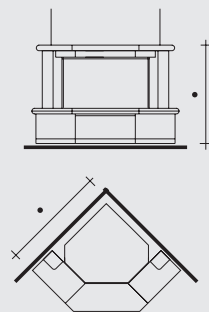
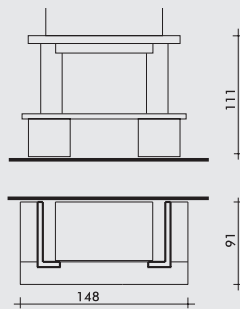
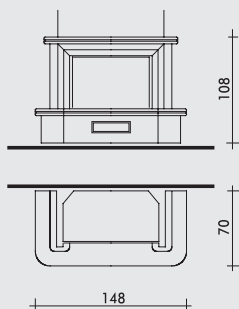
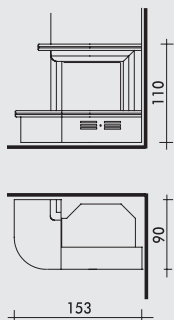

### FOCOLARI

Titano

Riga 54, Deco

Forte, Acquatondo 22

- Ego, 87,5x87,5x105h
- Status, 112x112x105h

## LEGO LINARES LUISA ANGOLO LUISA PARETE

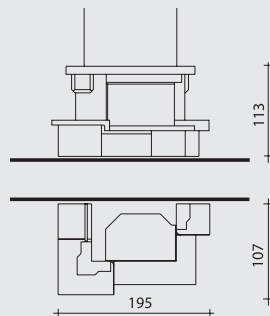
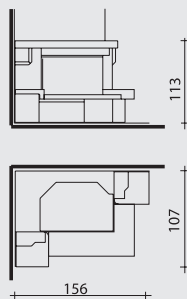
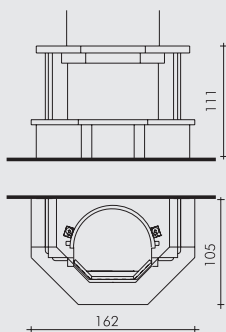
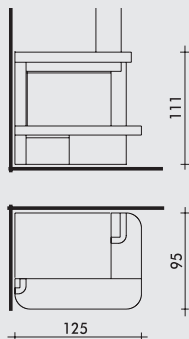

### FOCOLARI

Titano

Acquatondo 29

Titano

Titano

MAYA LATO APERTO

MAYA LATI CHIUSI

NOVELLA MEDIO/PICCOLO

ONDA

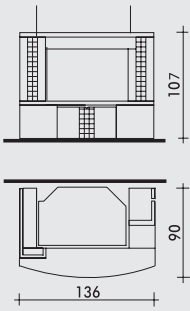

**FOCOLARI**

Titano

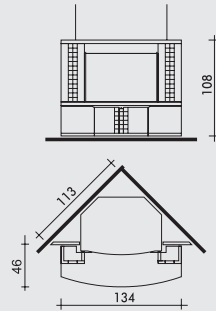

Forte

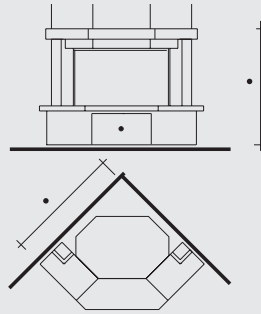

- Status, cm 113x113x113h
- Ego, cm 94x94x112h

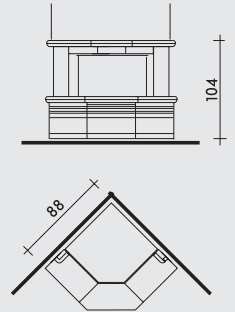

Ego

PARIGI

ROMA

SAXON

STONE

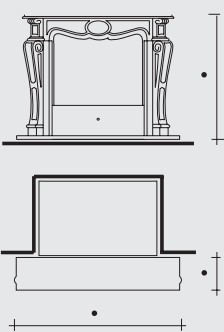

**FOCOLARI**

- Tonda, Piana, cm 155x30x117h
- Forte, 133x26x114h

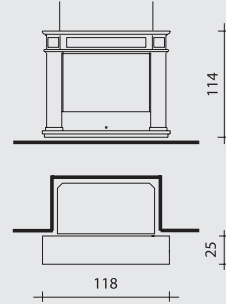

Forte

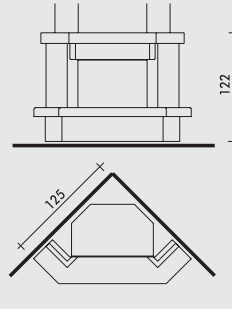

Forte, Acquatondo 22

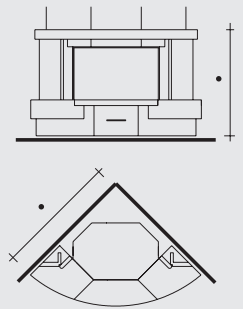

- Status, cm 128x128x112h
- Riga 54, Deco, Tonda, Piana, cm 120x120x112h

TEMA ANGOLO

TOSCA

TRIS MEDIO/PICCOLO

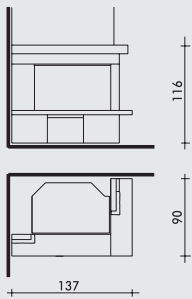

**FOCOLARI**

Titano

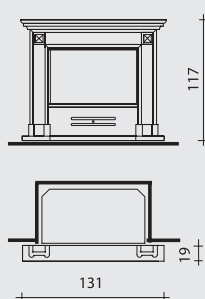

Forte

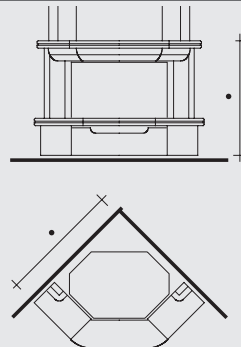

- Status, cm 112x112x110h
- Ego, 90x90x109h



## SU MISURA PER TE

Edilkamin ha messo a punto un servizio per soddisfare i Clienti con esigenze specifiche per quanto riguarda il rivestimento del caminetto. Partendo dalle singole richieste, l'Ufficio Tecnico è in grado di elaborare rapidamente e soprattutto con estrema professionalità, un preventivo gratuito per la realizzazione di rivestimenti personalizzati. Il passo successivo è la messa a punto di un disegno esecutivo che, dopo l'approvazione, servirà per la realizzazione nei laboratori dell'azienda del caminetto su misura, naturalmente utilizzando i materiali prescelti, tutti presenti nelle fotografie del catalogo.

**Marmi:** bianco bocciardato, giallo istria, bianco carrara, rosa asiago, rosa portogallo, verde guatemala, bronzettato, arabescato bianco, tigrato orientale, giallo reale, rosso verona, breccia aurora, tramonto rosso, rosso skiros, trani.

**Graniti:** windsor, nero assoluto.

### Travertino

**Agglomerati:** stonelite rosa, avorio, bianco, nero.

## NOTIZIE UTILI

Per ordinazioni di caminetti da collocare in angolo, si definisce "destro" il caminetto che andrà collocato nell'angolo a destra di chi osserva e viceversa.





## INDICE PER FOCOLARE

### **ACQUATONDO sfera 22**

Bahia

### **ACQUATONDO piano 22**

Air, Bix Box, Dromond, Gibilterra parete, Iron, Mexico, Sahara, Saxon, Silver

### **ACQUATONDO piano/cs 22**

Air, Bix Box, Dromond, Iron, Mexico, Sahara, Silver

### **ACQUATONDO piano 29**

Cordoba, Iron, Mexico, Silver

### **ACQUATONDO piano/cs 29**

Iron, Mexico, Silver

### **ACQUATONDO prismatico 29**

Andorra, Linares

### **AIRFIRE portellone prismatico**

Metal

### **AIRFIRE portellone piano**

Air, Bix box, Iron, Mexico, Onyx, Silver, White

### **AIRFIRE portellone tondo**

Door, Easy

### **CRISTAL 45 N**

Bix Box, Darvon, Dromond

### **CRISTAL 76 N**

Abbey, Air(bianco), Bix Box, Dromond, Iron, Silver

### **CRISTAL 90 N**

Bix Box, Dromond, Wall

### **DECO**

Alicante, Aragona, Dama, Diva, Domino, Filorosso, Stone.

*Mediante cornice optional:*

Air, Arabesque, Bold, Fashion, High Tech, Incas, Iron, Jungle, Sahara, Silver, Wind, Wood.

### **DOUBLE N**

Air (bianco), Bix Box, Iron, Silver

### **EGO**

Abaco, Elios, Lady piccolo, Novella piccolo, Onda, Tris

### **FIRETRONIX Arc**

Door, Easy

### **FIRETRONIX Line**

Air, Bix Box, Iron, Mexico, Onyx, Silver, White

### **FIRETRONIX Poli**

Metal

### **FLAT 100 N**

Bix Box 100, Iron, Sahara 100, Silver

### **FLAT 120 N**

Foco, Pop

### **FORTE**

Air, Bix Box, Class, Dromond (bianco), Foco, Gibilterra, Iron, Maya, Mexico, Parigi due, Roma due, Sahara, Saxon, Silver, Square, Tosca

### **IDRO 30**

Quadro

### **LUCE 54/62**

Air, Arabesque, Bix Box 62, Bold, Fashion, High Tech, Incas, Iron, Jungle, Sahara, Silver, Wind, Wood

### **LUCE PLUS 54/62**

Air, Arabesque, Bix Box 62, Bold, Fashion, High Tech, Incas, Iron, Jungle, Sahara, Silver, Wind, Wood

### **PELLBOX SCF**

Air, Arabesque, Bix Box 62, Bold, Fashion, High Tech, Incas, Iron, Jungle, Sahara, Silver, Wind, Wood

### **PELLINSERT 54**

Air, Arabesque, Bold, Fashion, High Tech, Incas, Iron, Jungle, Sahara, Silver, Wind, Wood

### **PIANA**

Domino, Parigi uno, Stone.

*Mediante cornice optional:*

Air, Arabesque, Bix Box, Bold, Fashion, High Tech, Incas, Iron, Jungle, Sahara, Silver, Wind, Wood

### **RIGA 54**

Alicante, Aragona, Dama, Diva, Domino, Filorosso, Stone.

*Mediante cornice optional:*

Air, Arabesque, Bold, Fashion, High Tech, Incas, Iron, Jungle, Sahara, Silver, Wind, Wood.

### **SCREEN 80/100**

Grey, Laser, Mexico(solo mod. 80), Pure, Safari, Smile, Steel

### **STATUS**

Abaco, Elios, Lady medio, Novella medio, Stone, Tris

### **STILE**

Canaria, Carousel, Dromond

### **THERMOFIRE**

#### **portellone piano - piano/cs**

Air, Bix box, Iron, Mexico, Onyx, Silver, White

### **TITANO**

Derby, Filorosso, Lego, Luisa V, Maya, Tema

### **TONDA**

Domino, Parigi uno, Stone

## INDICE ANALITICO

<b>FOCOLARI ad aria/acqua</b>		<b>RIVESTIMENTI</b>			
ACQUATONDO lato vetrato	33	ABACO	66	LUISA V	70
ACQUATONDO piano	32	ABBEY	52	MAYA	64
ACQUATONDO prismatico	33	AIR	39	METAL	52
ACQUATONDO sfera	32	ALICANTE	58	MEXICO	47
AIRFIRE anta piano	15	ANDORRA	73	NOVELLA	72
AIRFIRE portellone piano	14	ARABESQUE	44	ONDA	65
AIRFIRE portellone prism.	15	ARAGONA	73	ONYX	44
AIRFIRE portellone tondo	15	BAHIA	68	PARIGI	58
CRISTAL 45	11	BIX BOX	50	POP	41
CRISTAL 76	11	BIX BOX 62	50	PURE	55
CRISTAL 90	12	BIX BOX 100	50	QUADRO	48
DECO	24	BOLD	46	ROMA	60
DOUBLE	12	CANARIA	61	SAFARI	56
EGO	17	CAROUSEL	61	SAHARA	42
FLAT 100	13	CLASS	59	SAHARA 100	42
FLAT 120	13	CORDOBA	69	SAXON	69
FIRETRONIX Line	20	DAMA	72	SILVER	53
FIRETRONIX Poli	21	DARVON	48	SMILE	55
FIRETRONIX Arc	21	DERBY	73	SQUARE	38
FORTE	19	DIVA MEDIO	65	STEEL	57
IDRO 30	31	DOMINO	67	STONE	67
LUCE PLUS 54/62	22	DOOR	49	TEMA	71
LUCE 54/62 piana	23	DROMOND	51	TOSCA	59
LUCE 54/62 tonda	23	EASY	54	TRIS	62
PELLINSERT 54	27	ELIOS	70	WALL	45
PELLBOX SCN	26	FASHION	46	WHITE	53
PELLBOX SCF	27	FILOROSSO	62	WIND	40
PIANA	24	FOCO	40	WOOD	45
RIGA 49	25	GIBILTERRA	71		
RIGA 49/1L	25	GREY	57		
RIGA 54	25	HIGH TECH	43		
SCREEN 80 - 100	9	INCAS	47		
STATUS	18	IRON	54		
STILE	17	JUNGLE	43		
THERMOFIRE port. piano	35	LADY	63		
THERMOFIRE anta piano	35	LASER	56	<b>Accessori</b>	30/74/75
TITANO	18	LEGO	66	<b>Dati tecnici</b>	76
TONDA	24	LINARES	68	<b>Disegni tecnici</b>	78

Presso i rivenditori specializzati è possibile visionare  
la gamma della produzione Edilkamin.



**EDILKAMIN**  
TECNOLOGIA DEL FUOCO

20020 Lainate (MILANO) • via Mascagni, 7  
telefono +39 02.937.62.1 • fax +39 02.937.62.400  
mail@edilkamin.com • [www.edilkamin.com](http://www.edilkamin.com)